

# Vembu VMBackup

vembu



# Vembu Technologies



Experience



100+ Countries

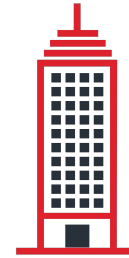

Headquartered in  
Chennai

# Vembu BDR Suite

Vembu BDR Suite is a portfolio of products designed to backup multiple environments from virtual to physical to cloud while addressing diverse and advanced use cases



## **VMBackup**

Backup & Replication for  
VMware and Hyper-V



## **ImageBackup**

Backup & BMR for Physical  
Windows Servers and  
Desktops



## **NetworkBackup**

Backup for files/folders &  
applications



## **OffsiteDR**

Replicate a copy of your  
backup data off-site

# Understanding RPO and RTO

## RTO (Recovery Time Objective)

Time duration to recover a backed up machine after disaster



Until which point in time you can recover the machine data after disaster

## RPO (Recovery Point Objective)

# Recovery Time Objective (RTO)

- The time taken for a business to recover from the occurrence of a disaster is RTO
- Downtime is not something every business can afford
- With Vembu, you can recover your virtual machines within a matter of minutes
- Vembu adheres to the industry best RTO and RPO of <15 minutes

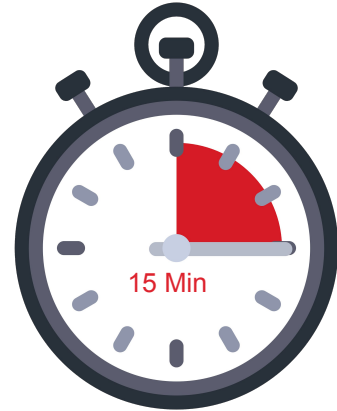

# Recovery Point Objective (RPO)

- The RPO for your business can be set by the maximum amount of data that you can afford to lose if disaster strikes
- With Vembu, you can retain even years worth of data
- You can also backup as frequently as every 15 minutes
- Also, near Continuous Data Protection ensures that you don't lose even minutes' worth of data

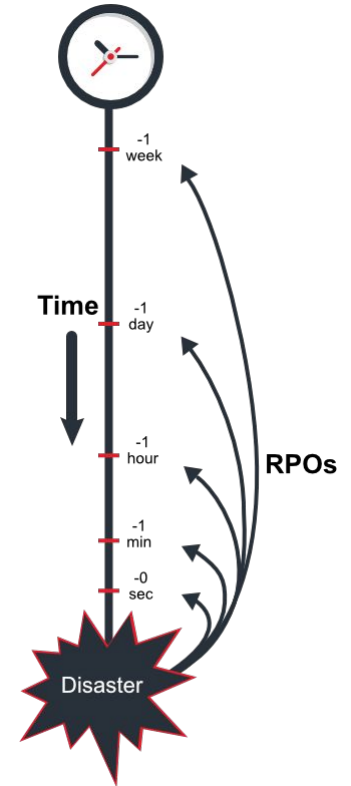



# Deployment



# On-premise Deployment - Simple

- Ideal setup for businesses looking to manage backups within their premises
- Setup DR site in your local environment and backup via LAN connections
- Configure and manage backup jobs from BDR Backup Server GUI
- Backup VMs to the local storage repositories

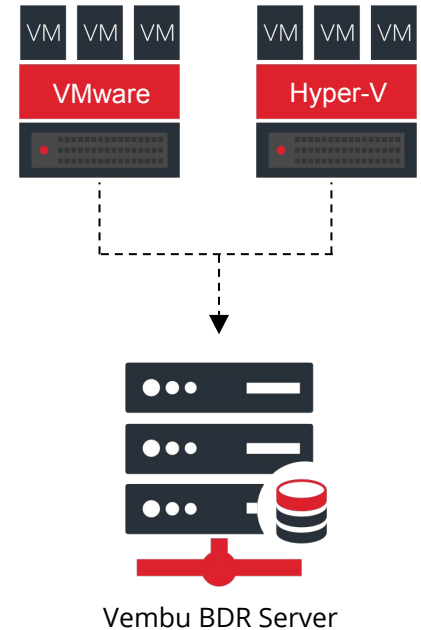



# On-premise Deployment - Distributed

- This deployment is recommended for large environments
- Setup DR site in your local environment and backup via LAN connections
- VMBackup agent can be used to configure and manage backup jobs
- Backup VMs to local storage repositories

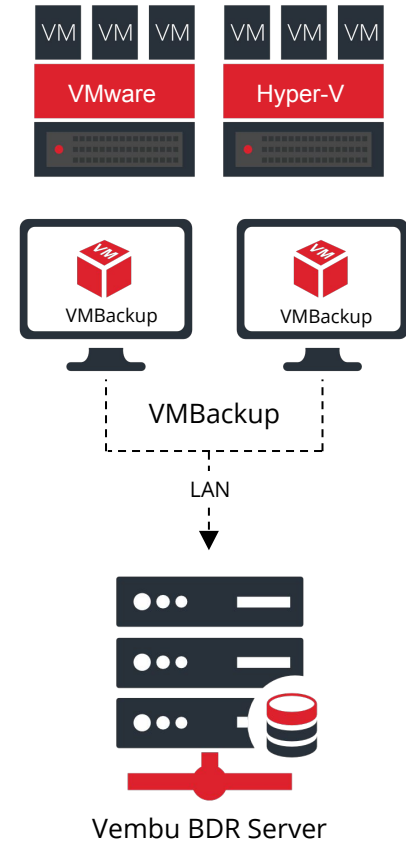

# Hybrid Deployment - Scenario 1 (OffsiteDR)

- This deployment is recommended for large environments
- Setup DR site in your local environment and backup via LAN connections
- Send another copy of backup data to your own datacenter via LAN/WAN connection
- Ensure a disaster-resistant environment by signing up for Vembu OffsiteDR

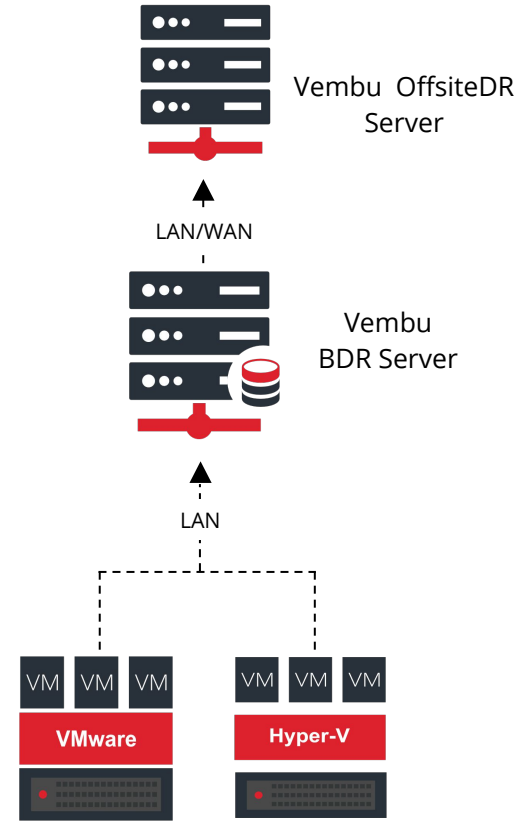

## Hybrid Deployment - Scenario 2 (CloudDR)

- This deployment is recommended for large environments
- Setup DR site in your local environment and backup via LAN connections
- Send another copy of backup data to Vembu Cloud via WAN connection
- Ensure a disaster-resistant environment by signing up for Vembu CloudDR

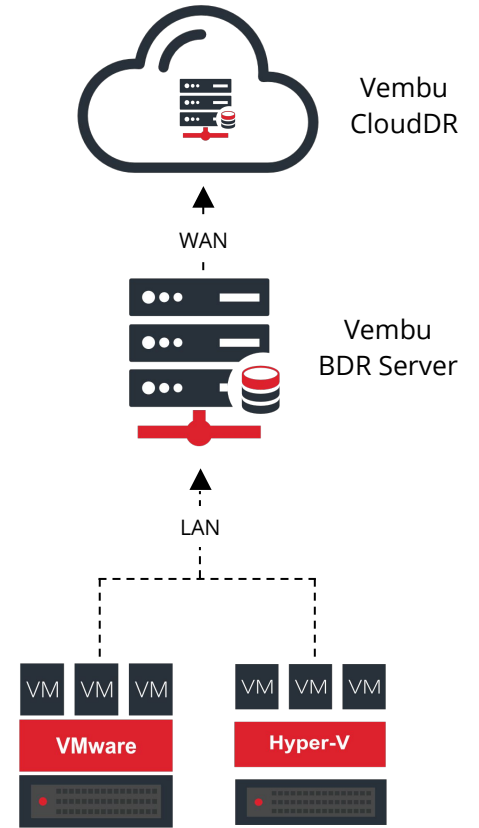

# Offsite (or) Remote Deployment (CSP)

- Cloud Service Providers can host Vembu OffsiteDR Server on their data center
- They can backup another copy of data from Vembu BDR Backup Servers to their data center over WAN

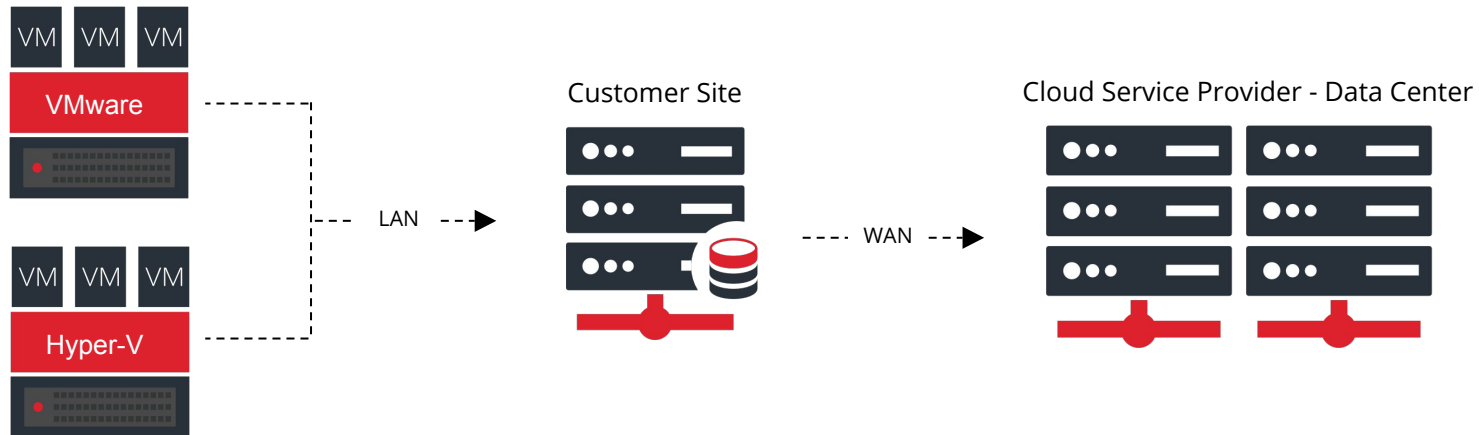

## Remote office/Branch office

- Setup Vembu BDR backup server and Vembu Offsite DR server in remote office as well as branch office
- Sync backup data between both the locations

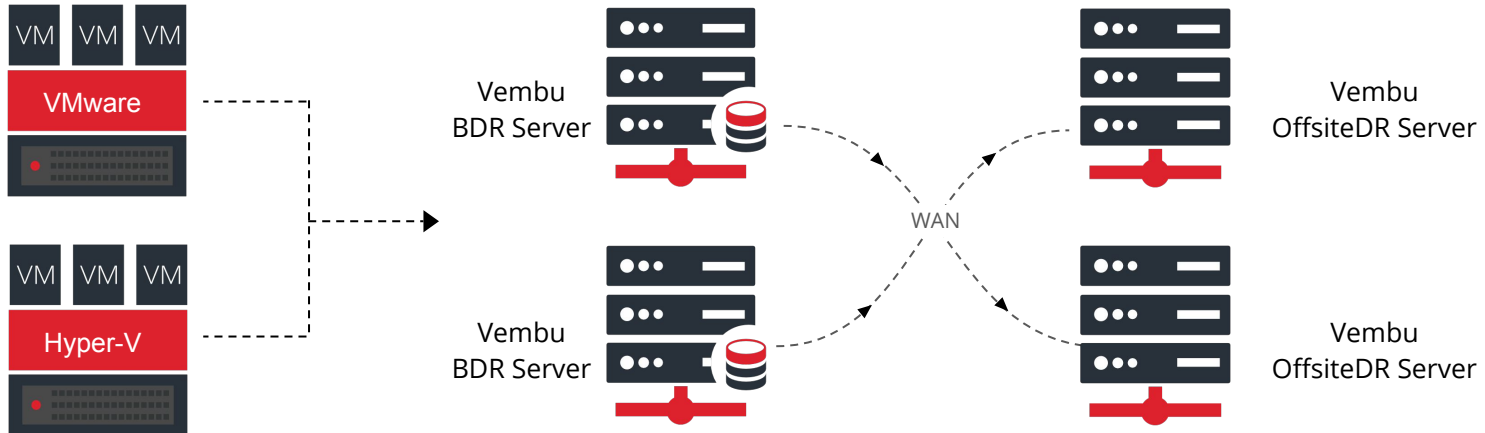

# Backup Server Clustering

- You can easily scale up the backup server when backup load increases
- Backup requests will be equally shared between each backup server

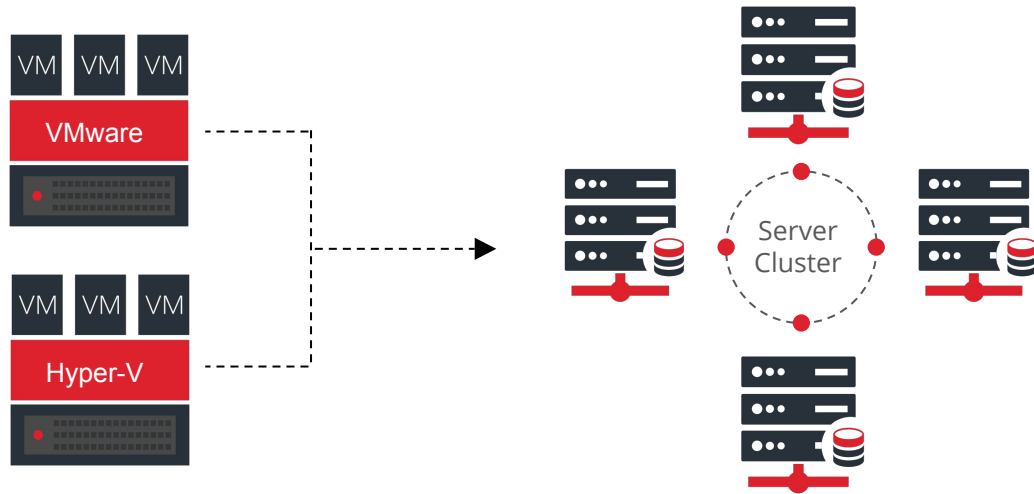

# Product Highlights



# Application Aware Process

Application-aware process is to create consistent database snapshots.

- This option allows you to stop the backup if any of the MS application writers are in an unstable state
- Transaction log files can also be truncated. If not, then they can accumulate until they fill all the available disk space





# Compression and Encryption

- The backup data is compressed to reduce the storage needs
- The backup data is also encrypted using AES 256 algorithm both in-flight and at rest
- Users can save multiple customized encryption passwords along with a unique hint to ensure double protection for the backed up data

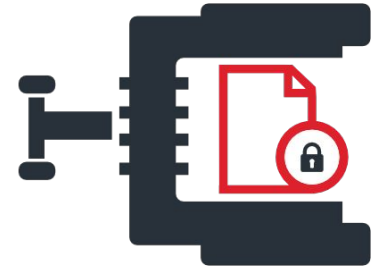

# Backup Verification

- Backup verification can be automated to run post completion of every backup schedule or once in a day
- In the process, booting of backed up VM will be carried out and screenshot of boot screen will be captured. The screenshot details will be sent to the administrators via email



# Efficient Storage Management

Vembu BDR Backup Server utilizes VembuHIVE™ file system to effectively manage storage repositories.

- Supports SAN, NAS and DAS
- Automatically scale up/scale out the storage devices
- In-built version control and error correction
- In-built Compression & Encryption



# Migration Plan (P2V and V2V)

Vembu supports migration of machines from one environment to another.

- Vembu supports instant creation of VMDK, VHD and RAW files for backed up virtual/physical machines
- Users can instantly start migrations like P2V(Physical to virtual) and V2V(between virtual environments)



# Native Tape Backup

Vembu Native Tape Backup support helps organisations in implementing the best known 3-2-1 backup strategy of having 3 copies of your data in 2 different storage media and 1 backup copy offsite.

- Backing up to Tape is the only feasible option for long-term archival
- Automatically copy the backup data stored in Vembu BDR server to Tape Storage
- Media pools can be created for specific set of backup jobs and data can be efficiently archived

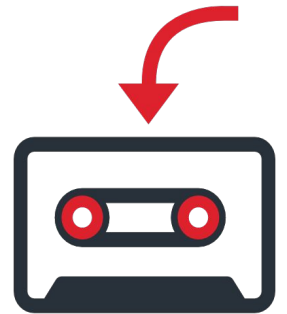

# Vembu Universal Explorer

It is a tool that helps you recover individual items from various Microsoft Application backups like Exchange, SQL, SharePoint and AD.

- Instantly restore emails/mailboxes from MS Exchange
- Instantly restore MS SQL databases and tables
- Restore documents of MS SharePoint
- Granularly recover MS Active Directory items



# Managing Backup & Replication Jobs

Using Vembu, you can automate the backup process by scheduling through the web console. Once set, the incrementals will run as per the configuration and no manual intervention is required.

- Add backup schedule window settings if you don't want to run incrementals during non working hours
- Auto Authorization feature ensures that only the authorized clients can connect to the BDR
- Bandwidth Throttling enables you to limit the bandwidth used by the backup process from the client machine

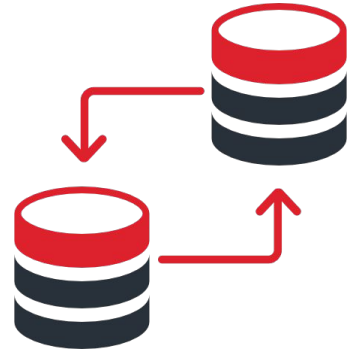



# Architecture





# Vembu VMBackup - Architecture

- Vembu VMBackup agent will communicate with VMware ESXi production storage and backup the VM data
- The agent works as a proxy between the ESXi host and Vembu BDR Backup Server

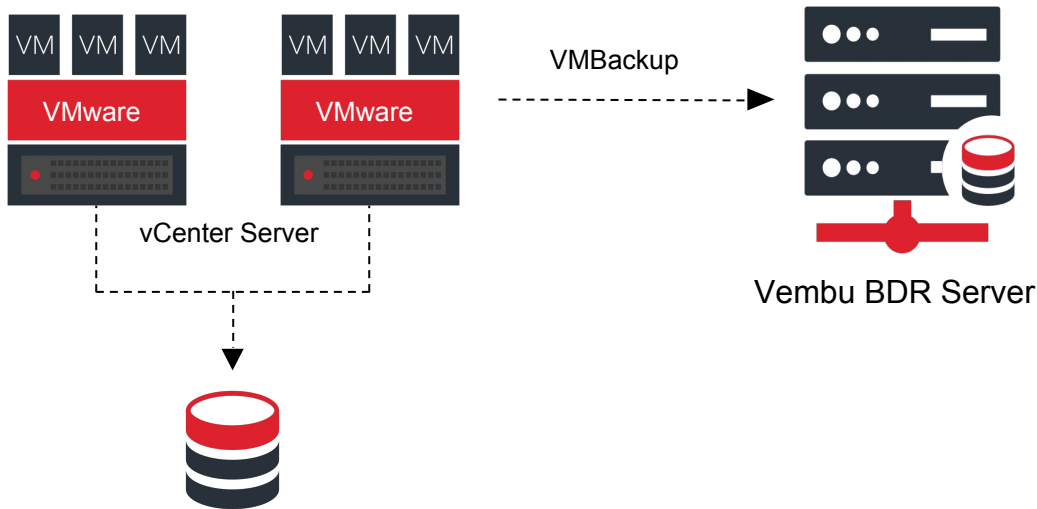

# VMReplication - Architecture

- Vembu VMBackup agent will replicate the VM data to another ESXi host
- Replicated VM will be in power-off mode
- Supports VM Failover and Failback

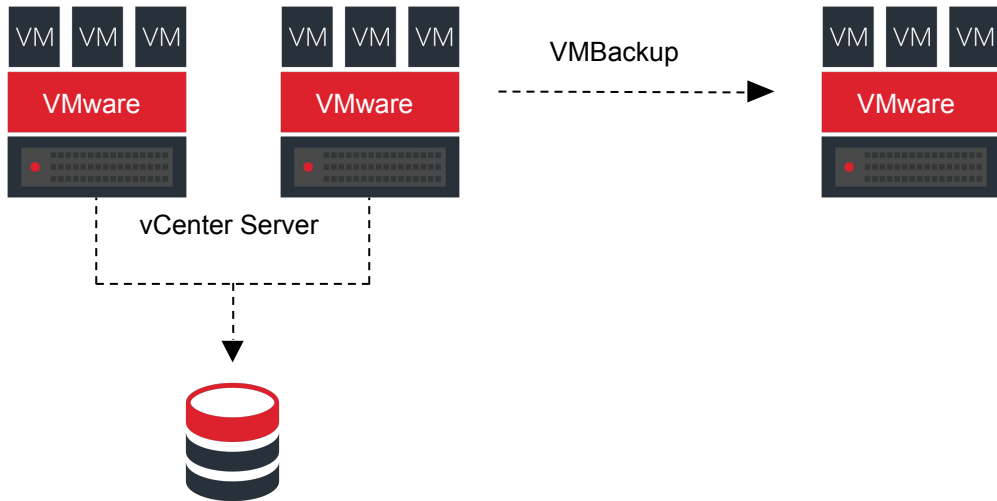

## Vembu VMBackup Client (proxy)

- This client is used to backup VMware and Hyper-V virtual machines
- It works as a proxy between the hypervisors and Vembu Backup Server
- Applies compression and encryption before sending the data to BDR backup server
- Replicates VM data from one VMware vSphere/Microsoft Hyper-V to another for High Availability
- Agent can be installed on Windows based physical or virtual machines

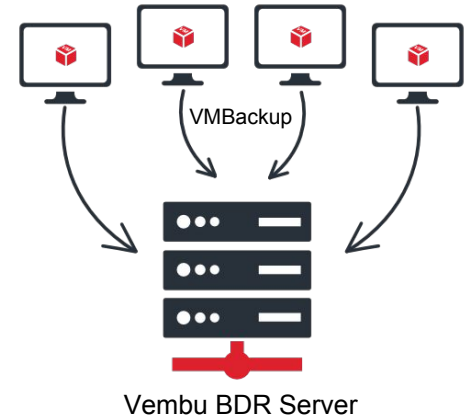

# Disaster Recovery Scenarios



# Quick VM Recovery on any hypervisor

Instantly boot the backed up VM on VMware, Hyper-V and KVM by mounting to Vembu Virtual Drive

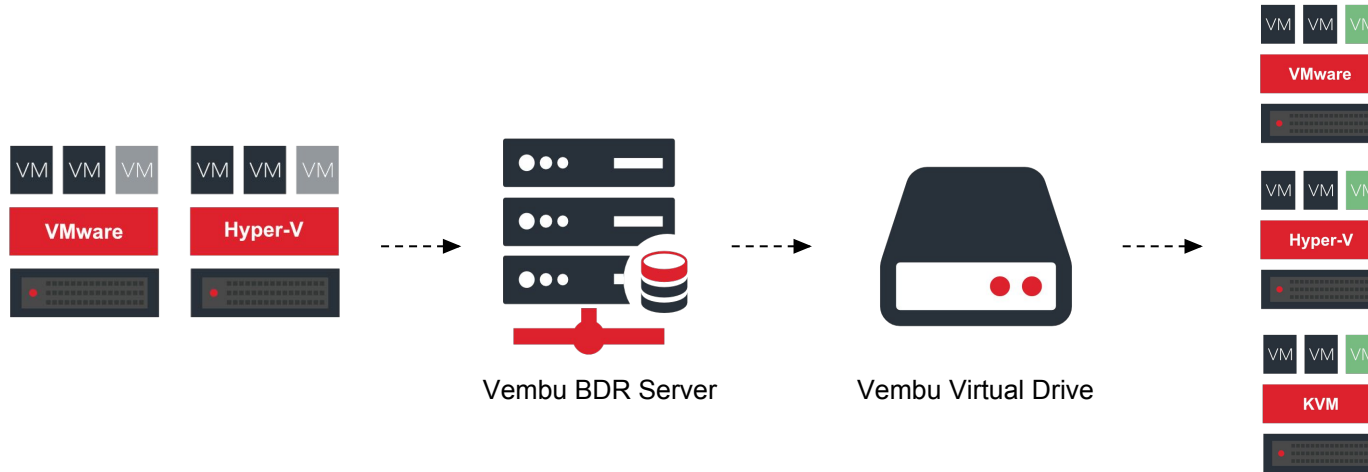

# Live VM Recovery

Restore the backed up VM permanently to the same or different ESXi host, Hyper-V host or KVM host

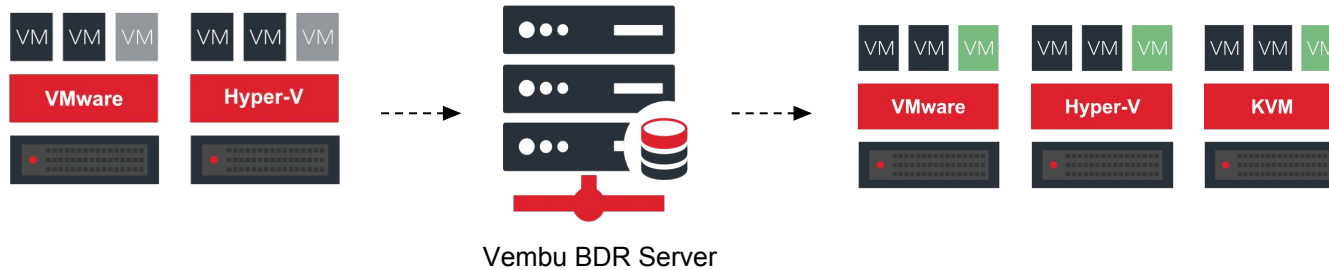

# File Level Recovery

Restore files/folders from the backed up VM instantly without having to restore the entire backed up VM

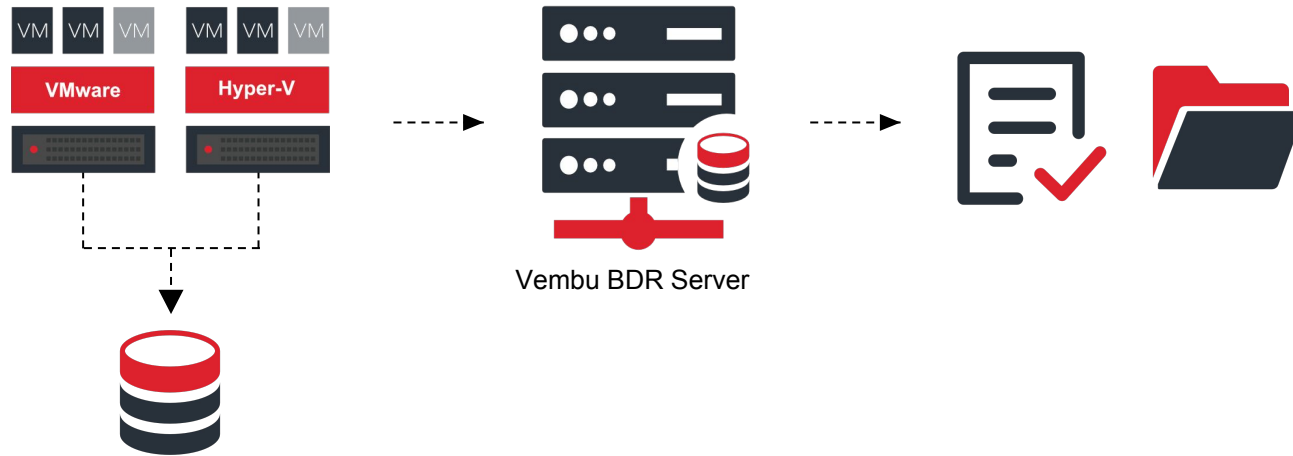

# VMReplication- Failover & Failback

- Instantly boot the replicated VM from the target ESXi host when your source VM is down
- Failed over VM can later be Failed Back to the source ESXi host or different host

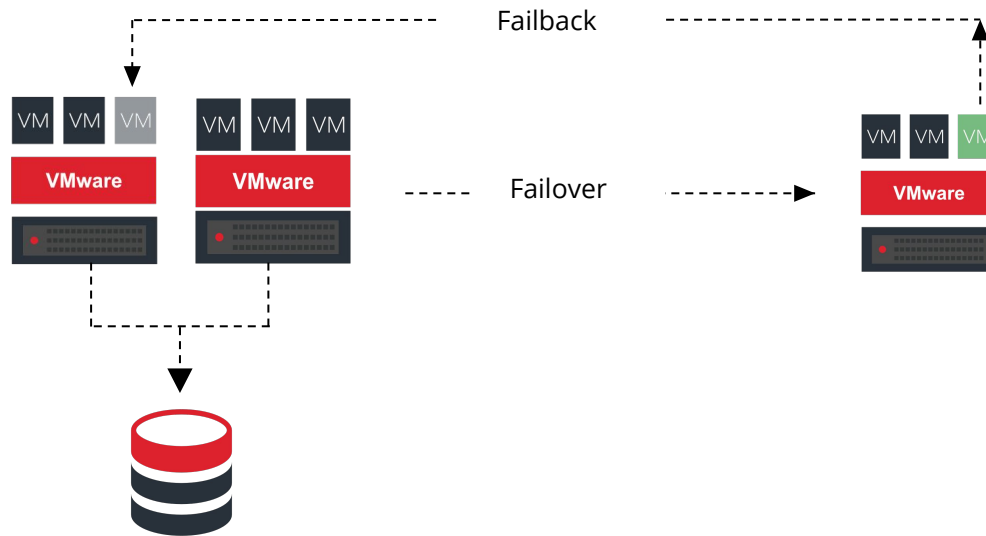



# Instant Item Level Recovery - Vembu Universal Explorer

Vembu Universal Explorer helps you restore Exchange mails, SQL database/tables, SharePoint documents and AD Users/Roles granularly

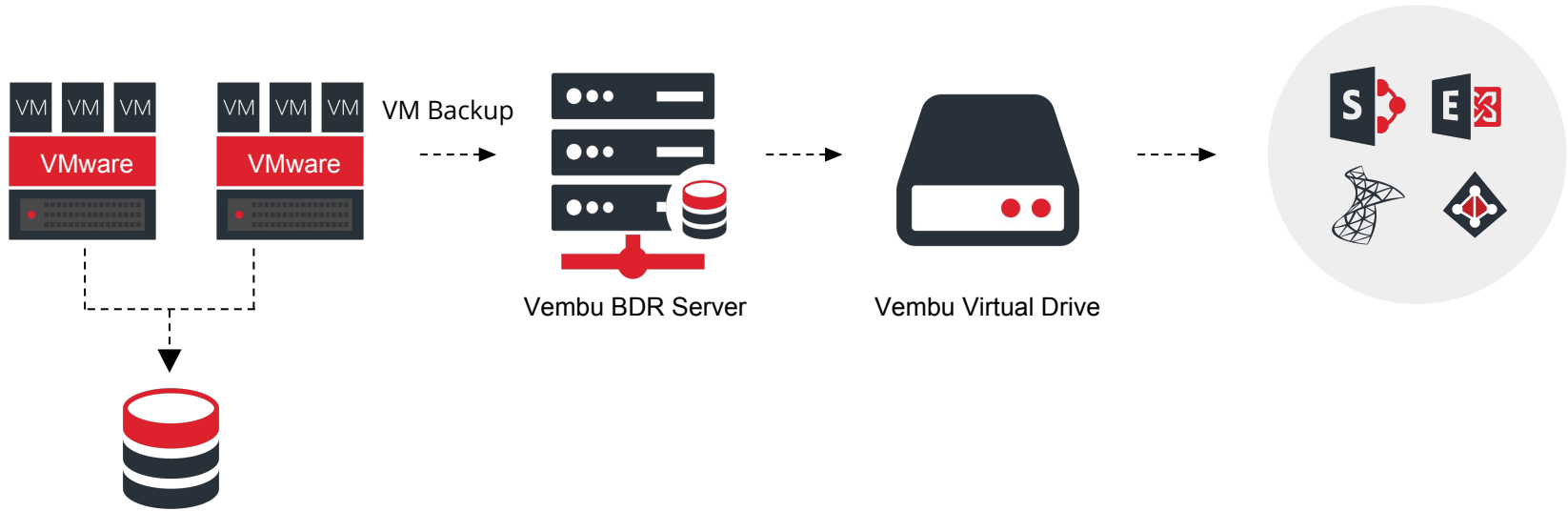

# Vembu Virtual Drive

- Vembu Virtual Drive will be available in Vembu BDR Backup Server machine and for every VM, it will create an IMG, VHD, VHDX, VMDK, VMX and RAW files instantly
- For every incremental schedule, full virtual hard disk files will be created without using any additional storage

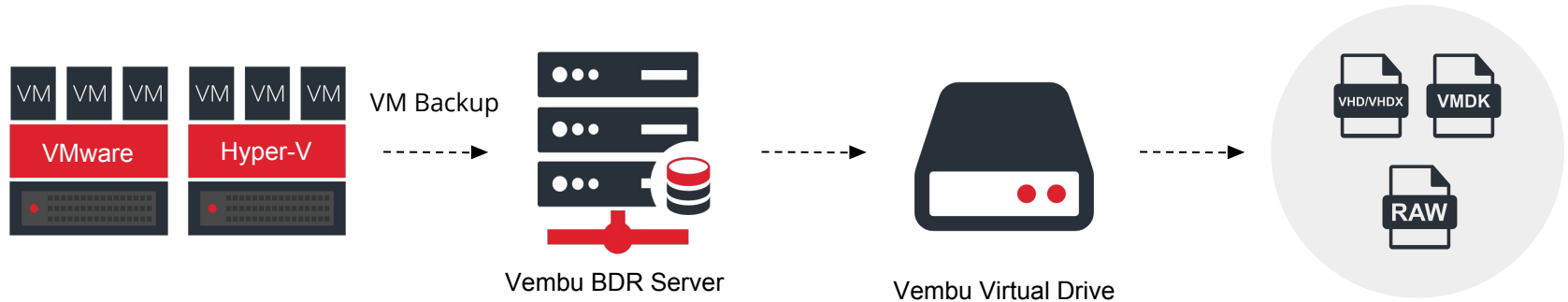



# Licensing & Pricing



# Licensing

## Subscription

- Vembu offers licensing options for 1, 2, 3 and 5 years
- 24/7 support and major/minor upgrades included

## Perpetual

- One time purchase with upgrades and support for one year
- AMC of 20% of license fee to be paid for continued support & updates

## Available Editions

- Free
- Standard
- Standard Essentials
- Enterprise
- Enterprise Essentials

# Pricing

- Vembu offers five pricing editions with features that cater to different levels of business requirements
- Check pricing here  
<https://www.vembu.com/vembu-bdr-suite-pricing/>





# Thank You

USA & CANADA  
+1-512-256-8699

UNITED KINGDOM  
+44-203-793-8668

Email

[vembu-sales@vembu.com](mailto:vembu-sales@vembu.com)  
[vembu-support@vembu.com](mailto:vembu-support@vembu.com)

[www.vembu.com](http://www.vembu.com)