

Hyper-V Backup - Enterprise edition

vembu



Vembu Technologies



Experience



100+ Countries

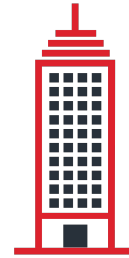

Headquartered in
Chennai

Vembu BDR Suite

Vembu BDR Suite is a portfolio of products designed to backup multiple environments from virtual to physical to cloud while addressing diverse and advanced use cases



VMBackup

Backup & Replication for
VMware and Hyper-V



ImageBackup

Backup & BMR for Physical
Windows Servers and
Desktops



NetworkBackup

Backup for files/folders &
applications



OffsiteDR

Replicate a copy of your
backup data off-site.

Understanding RPO and RTO

RTO (Recovery Time Objective)

Time duration to recover a backed up machine after disaster



Until which point in time you can recover the machine data after disaster

RPO (Recovery Point Objective)

Recovery Time Objective (RTO)

- The time taken for a business to recover from the occurrence of a disaster is RTO
- Downtime is not something every business can afford
- With Vembu, you can recover your virtual machines within a matter of minutes
- Vembu adheres to the industry best RTO and RPO of <15 minutes

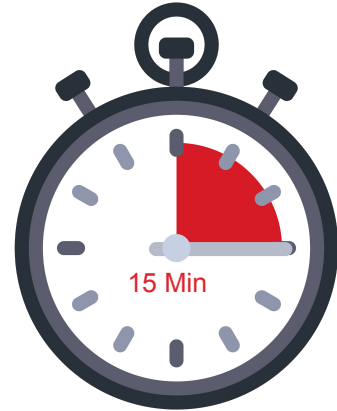

Recovery Point Objective (RPO)

- The RPO for your business can be set by the maximum amount of data that you can afford to lose if disaster strikes
- With Vembu, you can retain even years worth of data
- You can also backup as frequently as every 15 minutes
- Also, near Continuous Data Protection ensures that you don't lose even minutes' worth of data

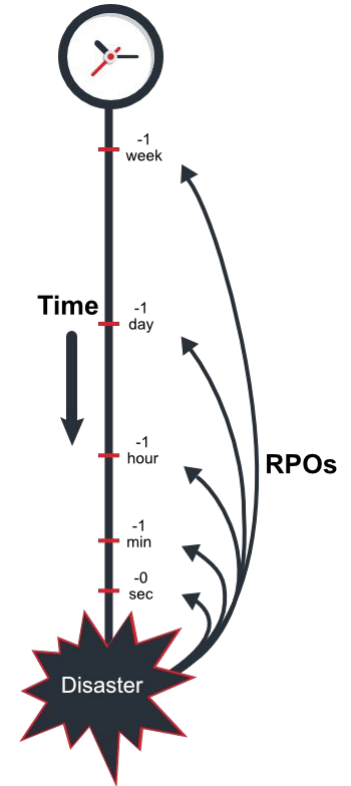



Deployment



On-premise Deployment - Simple

- Ideal setup for businesses looking to manage backups within their premises
- Setup DR site in your local environment and backup via LAN connections
- Configure and manage backup jobs from BDR Backup Server GUI
- Backup VMs to the local storage repositories

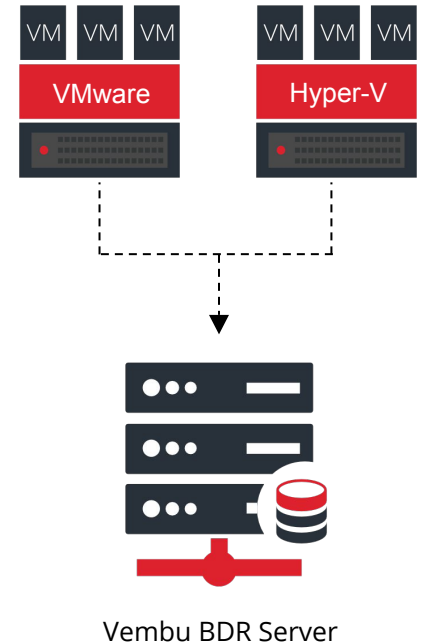

On-premise Deployment - Distributed

- This deployment is recommended for large environments
- Setup DR site in your local environment and backup via LAN connections
- VMBackup agent can be used to configure and manage backup jobs
- Backup VMs to local storage repositories

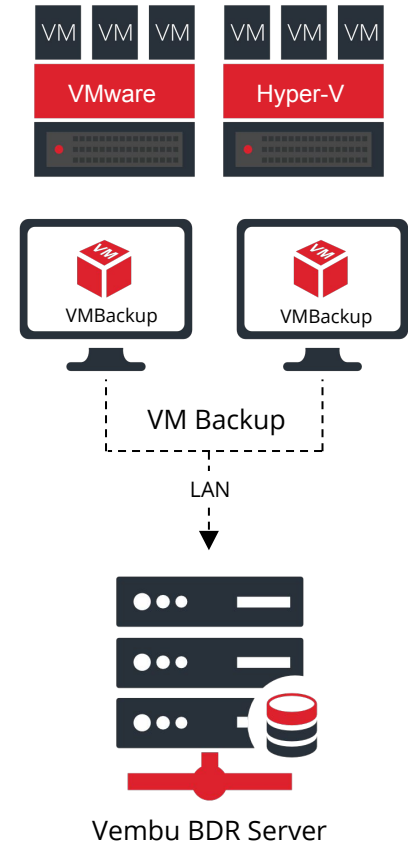

Hybrid Deployment - Scenario 1 (OffsiteDR)

- This deployment is recommended for large environments
- Setup DR site in your local environment and backup via LAN connections
- Send another copy of backup data to your own datacenter via LAN/WAN connection
- Ensure a disaster-resistant environment by signing up for Vembu OffsiteDR

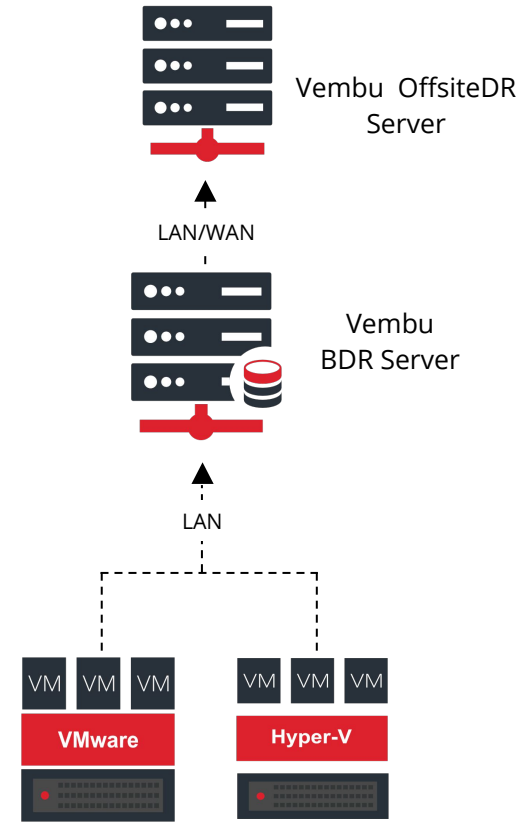

Hybrid Deployment - Scenario 2 (CloudDR)

- This deployment is recommended for large environments
- Setup DR site in your local environment and backup via LAN connections
- Send another copy of backup data to Vembu Cloud via WAN connection
- Ensure a disaster-resistant environment by signing up for Vembu CloudDR

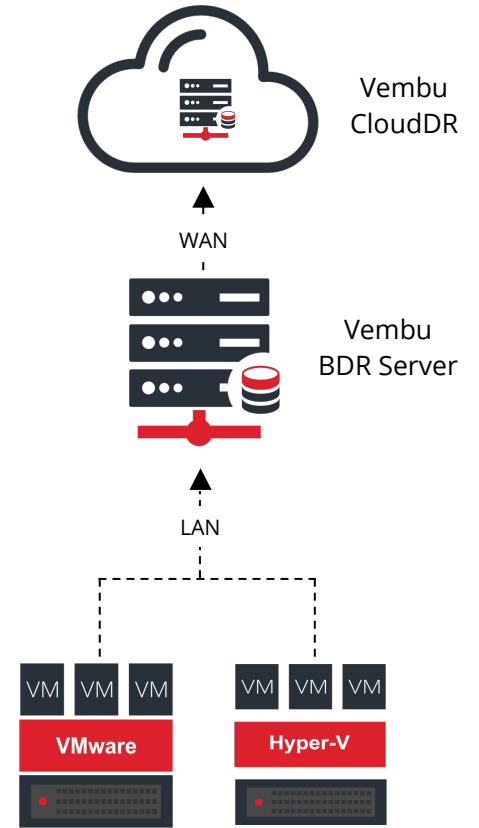

Offsite (or) Remote Deployment (CSP)

- Cloud Service Providers can host Vembu OffsiteDR Server on their data center
- They can backup another copy of data from Vembu BDR Backup Servers to their data center over WAN

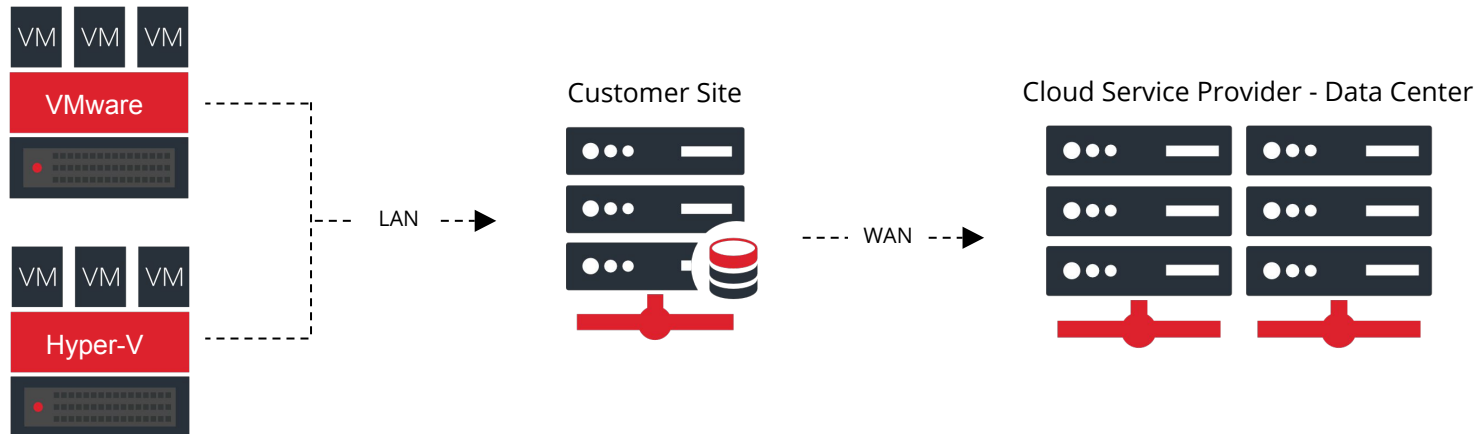

Remote office/Branch office

- Setup Vembu BDR backup server and Vembu Offsite DR server in remote office as well as branch office
- Sync backup data between both the locations

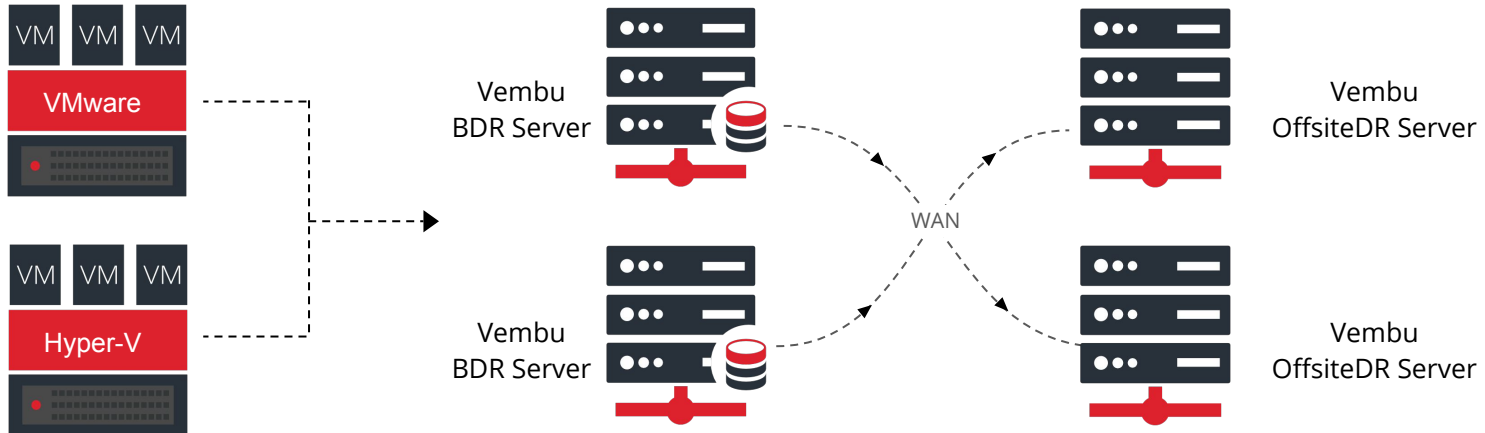

Backup Server Clustering

- You can easily scale up the backup server when backup load increases
- Backup requests will be equally shared between each backup server

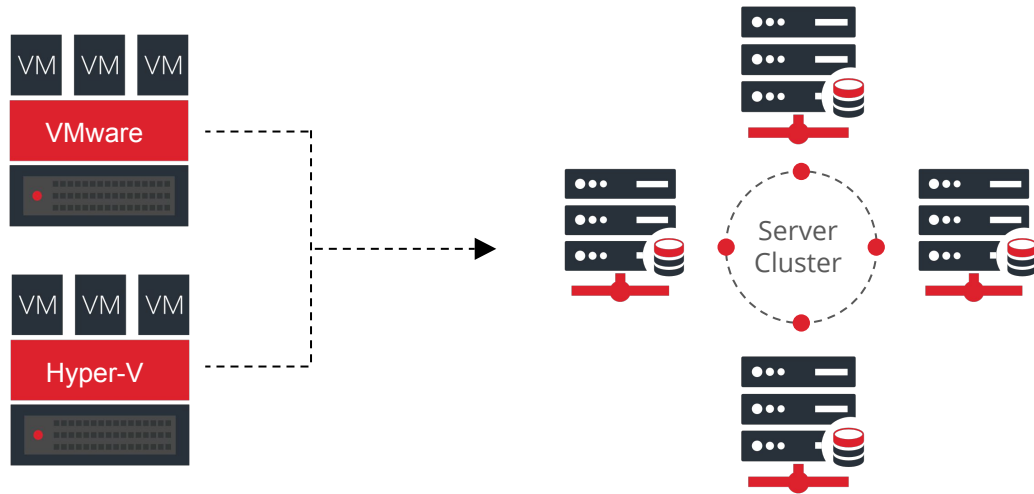

Product Highlights



Top Features

- Cluster support can help you ensure high availability for your Hyper-V VMs
- Host level Hyper-V backup is designed to protect Microsoft Hyper-V Servers
- CBT enabled incremental ensures high performance incremental backup
- Transaction log files can be truncated, if enabled. If not, then they can accumulate until they fill all the available disk space



Compression and Encryption

- The backup data is compressed to reduce the storage needs
- The backup data is also encrypted using AES 256 algorithm both in-flight and at rest
- Users can save multiple customized encryption passwords along with a unique hint to ensure double protection for the backed up data

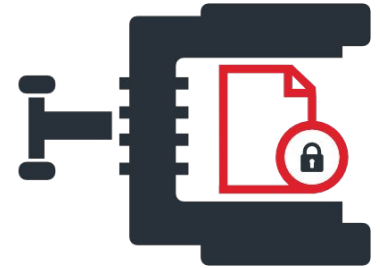

Backup Verification

- Backup verification can be automated to run post completion of every backup schedule or once in a day
- In the process, booting of backed up VM will be carried out and screenshot of boot screen will be captured. This screenshot details will be sent to the administrators via email



Efficient Storage Management

Vembu BDR Backup Server utilizes VembuHIVE™ file system to effectively manage storage repositories.

- Supports SAN, NAS and DAS
- Automatically scale up/scale out the storage devices
- In-built version control and error correction
- In-built Compression & Encryption



Migration Plan (P2V and V2V)

Vembu supports migration of machines from one environment to another.

- Vembu supports instant creation of VMDK, VHD and RAW files for backed up virtual/physical machines
- Users can instantly start migrations like P2V(Physical to virtual) and V2V(between virtual environments)

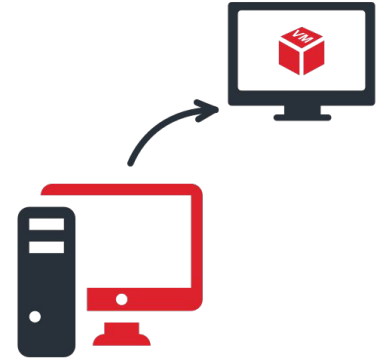

Native Tape Backup

Vembu Native Tape Backup support helps organisations in implementing the best known 3-2-1 backup strategy of having 3 copies of your data in 2 different storage media and 1 backup copy offsite.

- Backing up to Tape is the only feasible option for long-term archival
- Automatically copy the backup data stored in Vembu BDR server to Tape Storage
- Media pools can be created for specific set of backup jobs and data can be efficiently archived

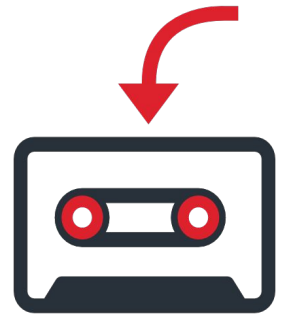

Vembu Universal Explorer

It is a tool that helps you recover individual items from various Microsoft Application backups like Exchange, SQL, SharePoint and AD.

- Instantly restore emails/mailboxes from MS Exchange
- Instantly restore MS SQL databases and tables
- Restore documents of MS SharePoint
- Granularly recover MS Active Directory items



Managing Backup Jobs

Using Vembu, you can automate the backup process by scheduling through the web console. Once set, the incrementals will run as per the configuration and no manual intervention is required.

- Add backup schedule window settings if you don't want to run incrementals during non working hours
- Auto Authorization feature ensures that only the authorized clients to connect to the BDR
- Bandwidth Throttling enables you to limit the bandwidth used by the backup process from the client machine

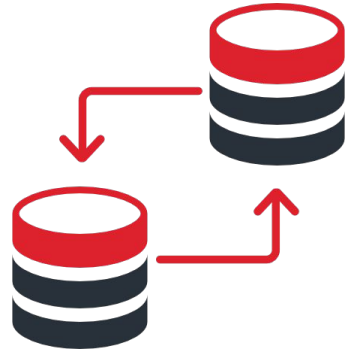



Architecture



Architecture - Hyper-V Backup

- Vembu VMBackup Client/Proxy is a transport software, which sits on the source Hyper-V Server and is used to process the VM data
- Vembu VMBackup Client works as a proxy between Hyper-V Server and Vembu BDR Backup Server
- Vembu VMBackup Client/Proxy backs up the VM data from the storage location and compresses, encrypts and delivers it to the Vembu BDR Backup server's storage repository

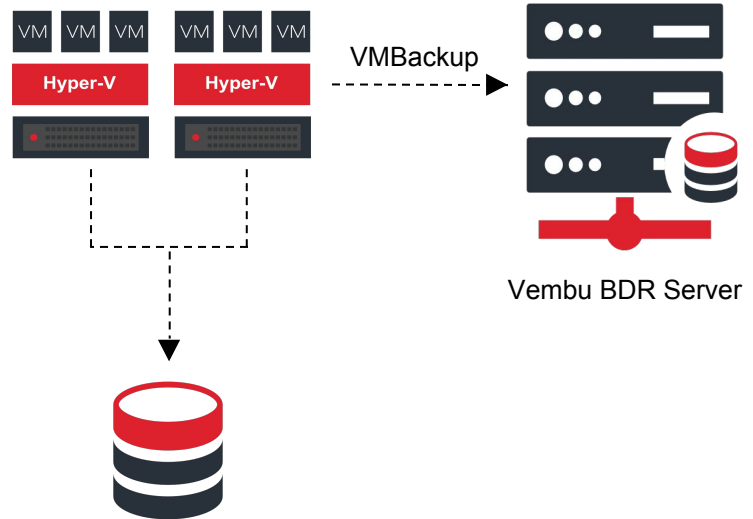

Disaster Recovery Scenarios



Quick VM Recovery on any hypervisor

Instantly boot the backed up VM on VMware, Hyper-V and KVM by mounting to Vembu Virtual Drive

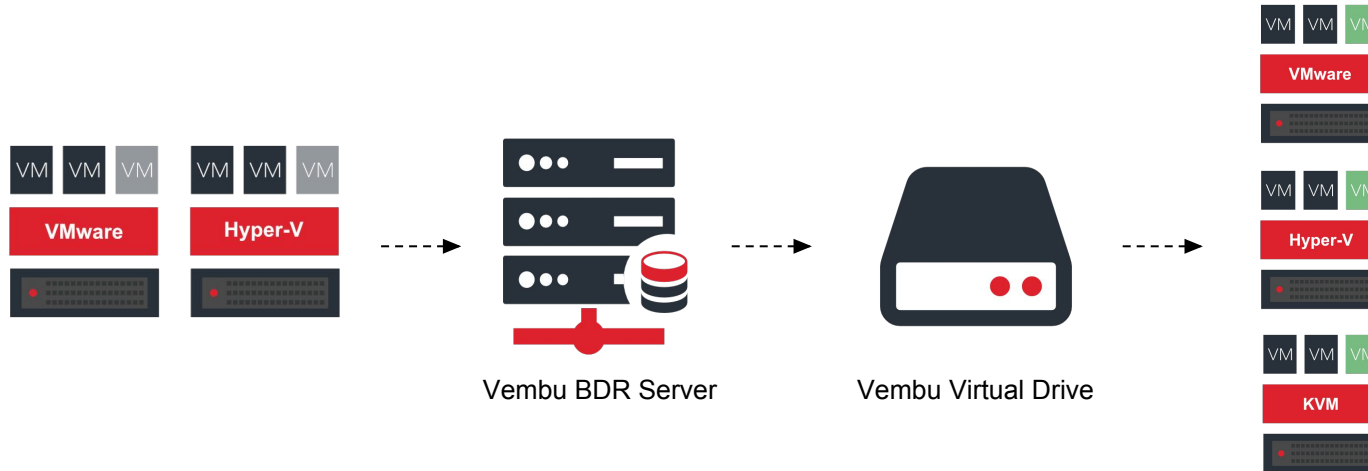

Live VM Recovery

Restore the backed up VM permanently to the same or different ESXi host, Hyper-V host or KVM host

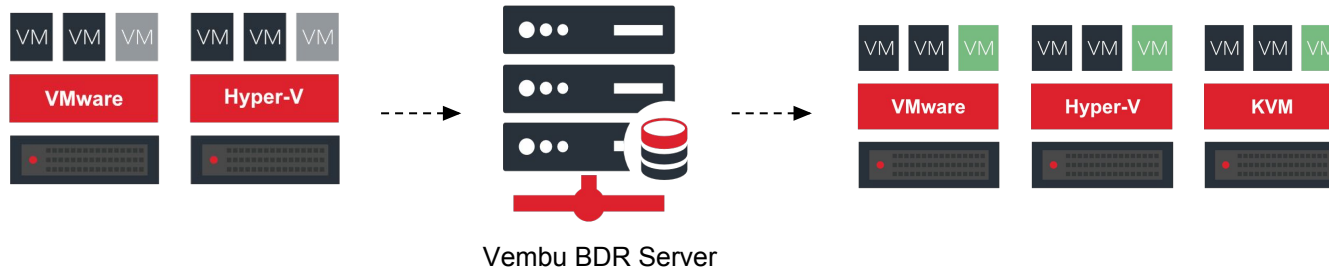

File Level Recovery

Restore files/folders from the backed up VM instantly without having to restore the entire backed up VM

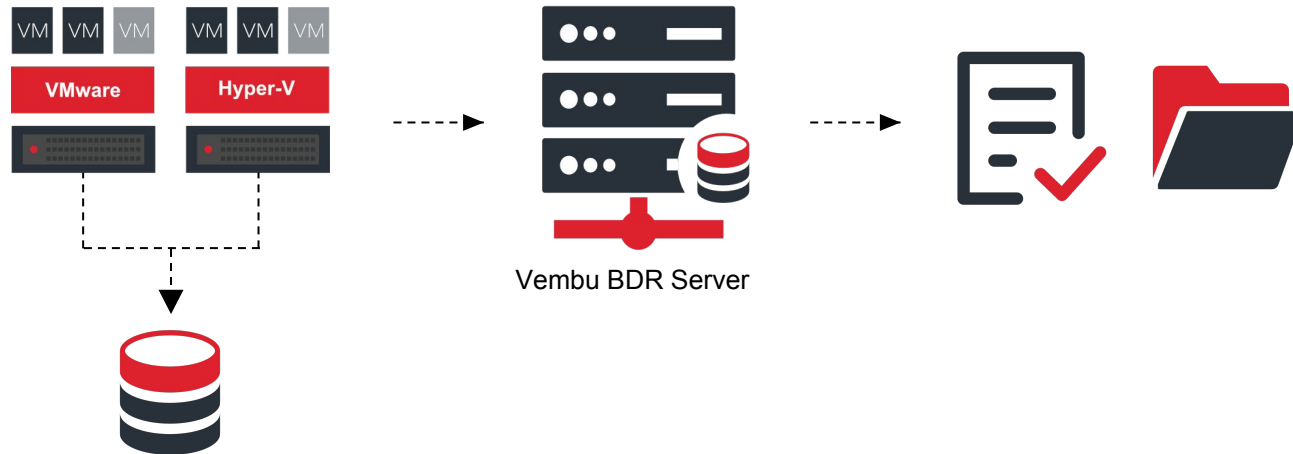

Instant Item Level Recovery - Vembu Universal Explorer

Vembu Universal Explorer helps you restore Exchange mails, SQL database/tables, SharePoint documents and AD Users/Roles granularly

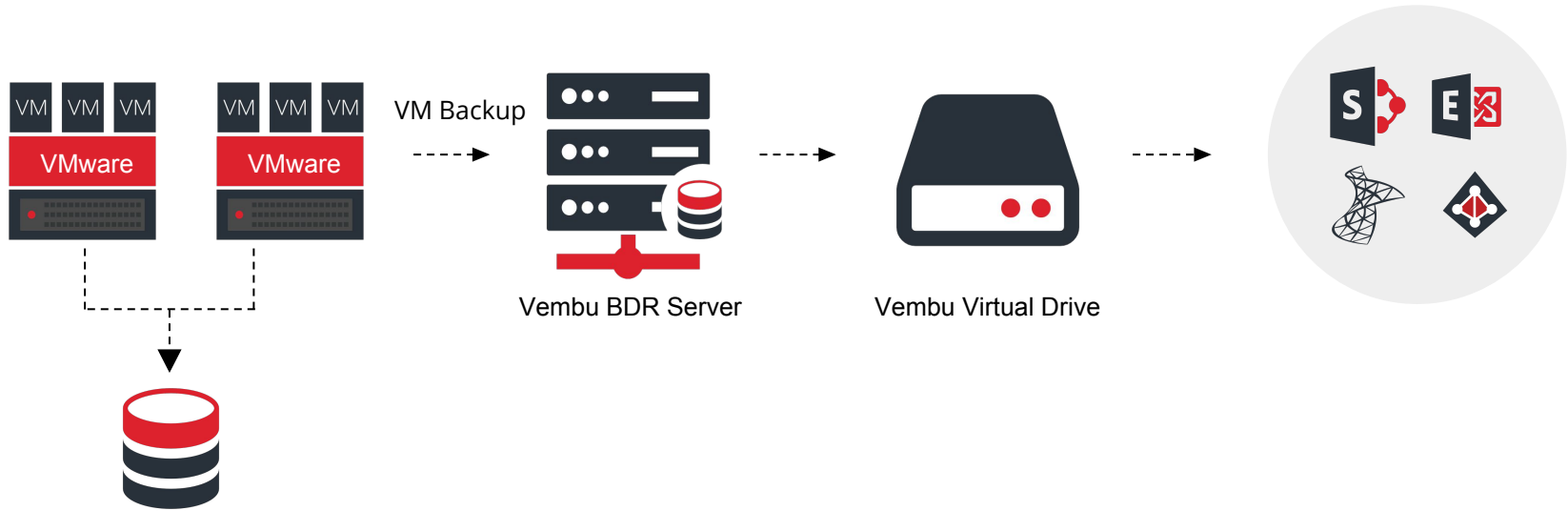

Vembu Virtual Drive

- Vembu Virtual Drive will be available in Vembu BDR Backup Server machine and for every VM, it will create an IMG, VHD, VHDX, VMDK, VMX and RAW files instantly
- For every incremental schedule, full virtual hard disk files will be created without using any additional storage

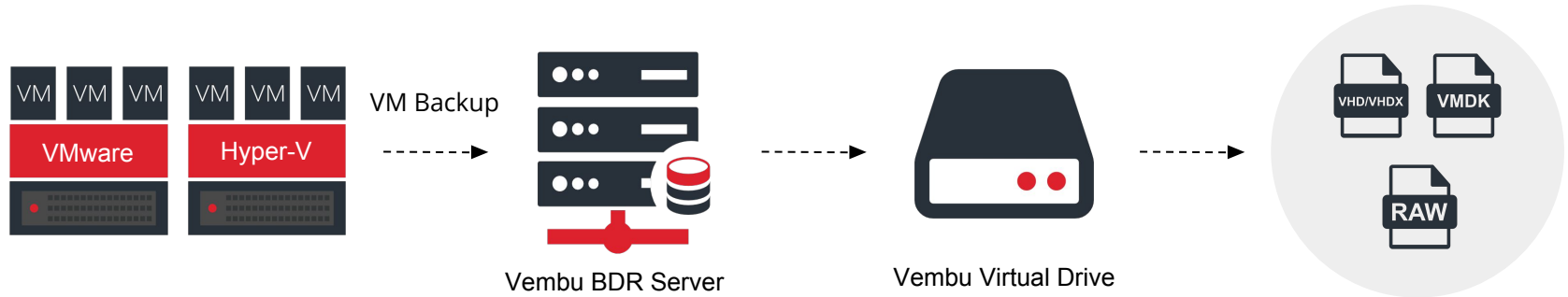



Licensing & Pricing



Licensing

Subscription

- Vembu offers licensing options for 1, 2, 3 and 5 years
- 24/7 support and major/minor upgrades included

Perpetual

- One time purchase with upgrades and support for one year
- AMC of 20% of license fee to be paid for continued support & updates

Available Editions

- Free
- Standard
- Standard Essentials
- Enterprise
- Enterprise Essentials

Pricing

- Vembu offers five pricing editions with features that cater to different levels of business requirements
- Check pricing here
<https://www.vembu.com/vembu-bdr-suite-pricing/>





Thank You

USA & CANADA
+1-512-256-8699

UNITED KINGDOM
+44-203-793-8668

Email

vembu-sales@vembu.com
vembu-support@vembu.com

www.vembu.com